

# DA IRON

## DA 120 / DA 180

Double action spring hinges prepared for traditional installation to be fixed with screws, as well as for installation by welding on frame and door. Maximum performance even with minimum tension.

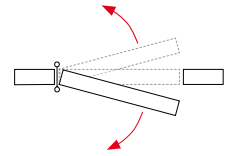

### Outside materials

- blade: steel zinc-plated
- adjustable cap and washers: carbon steel

### Inside materials

- inner axle: stainless steel AISI 304
- inner spring: steel (180) or stainless steel (120) blades set with protective grease

### Performance

- application: suitable for indoor/outdoor installation
- automatic return: yes
- adjustable return power: yes
- maximum door opening: 180°
- working cycles: up to 500.000

### Proper installation of 2 and 3 hinges

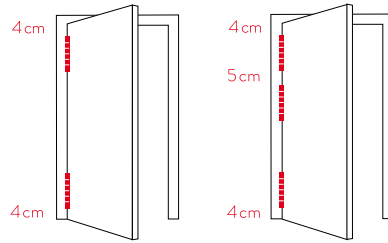

### Tension

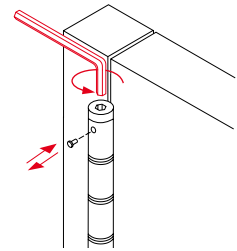

3-points adjusting cap

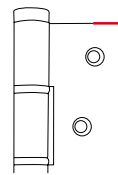

straight edge

## DA 120

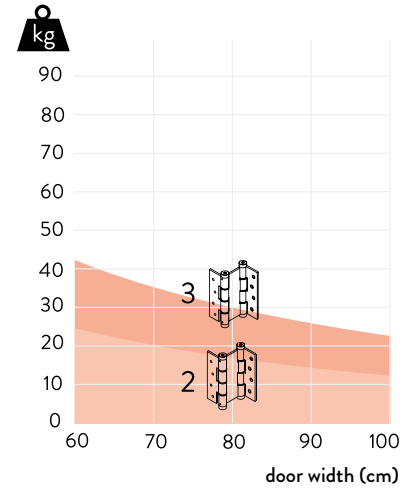
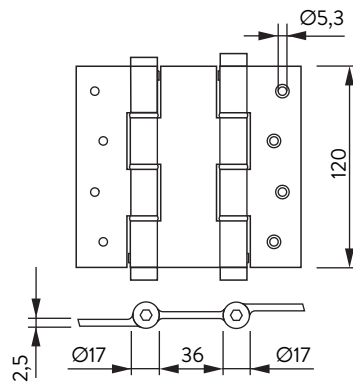
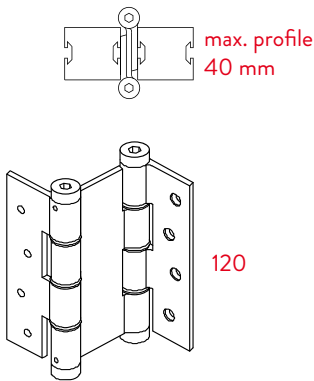

## DA 180

