

# DA ALUM

DA 120 / DA E 120 / DA 180 / DA E 180 / DA A 180

Frontisses d'alumini per a portes de vaivé, preparades per a una alta freqüència de pas. Dos models segons mida (120 o 180 mm). Disponibles en 3 amplituds diferents, 30 mm, 40 mm i 50 mm (només en DA 180), garanteixen solució a qualsevol necessitat.

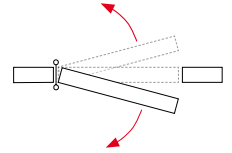

### Materials exterior

- pala: alumini anoditzat
- tap regulador: zamac
- volanderes separadores: poliamida

### Materials interior

- eix interior: acer inoxidable AISI 304
- molla interior: conjunt làmines d'acer (180) o acer inoxidable (120) amb greix de protecció

### Funcionament

- aplicació: apta la seva instal·lació interior/exterior
- retorn automàtic: sí
- regulable en potència: sí
- obertura màxima de treball: 180°
- cicles: més de 500.000

### Instal·lació correcta 2 i 3 frontisses

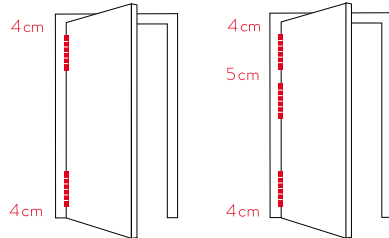

### Tensió

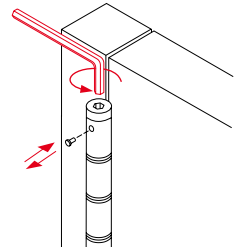

3 punts de tensió

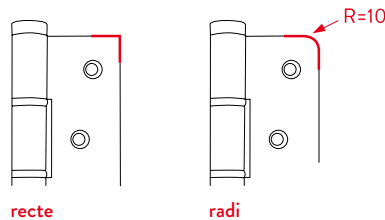

## DA E 120

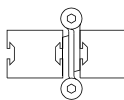

perfil màx 30 mm

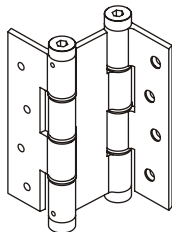

120

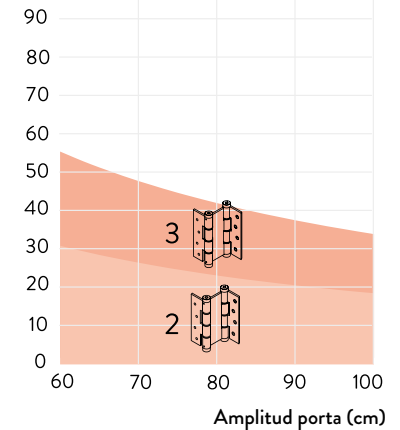
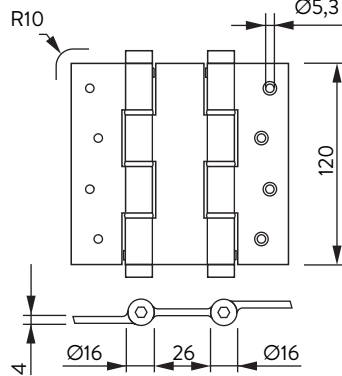

## DA 120

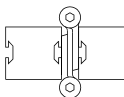

perfil màx 40 mm

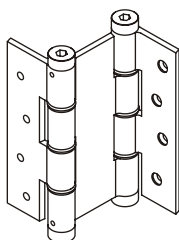

120

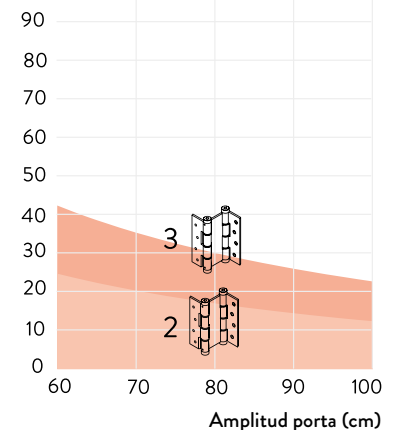
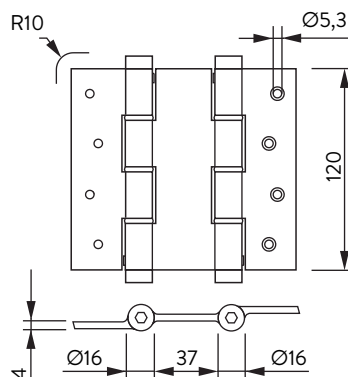

**DA E**  
180

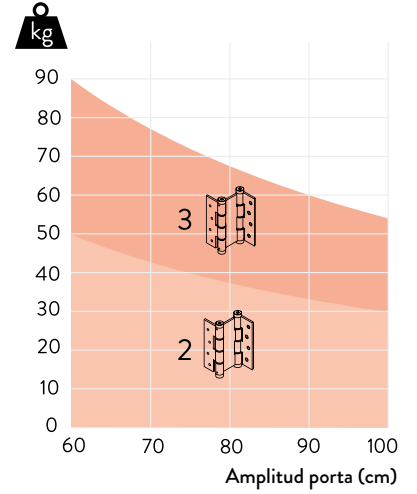
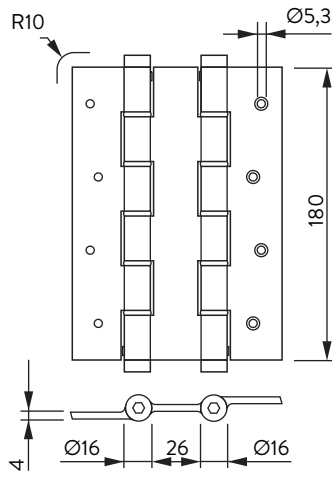
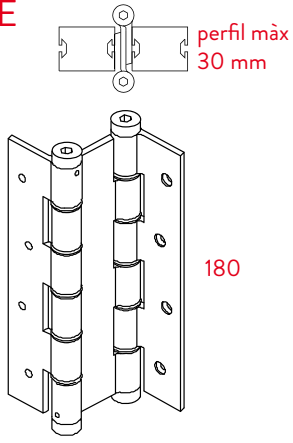

**DA**  
180

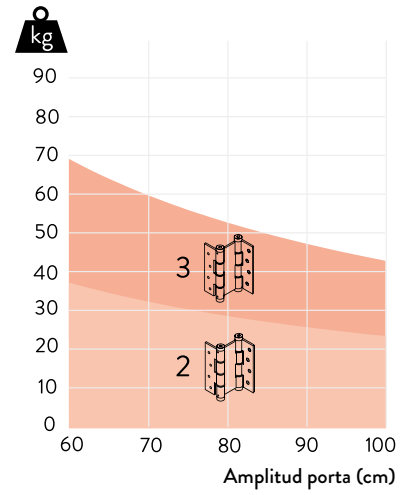
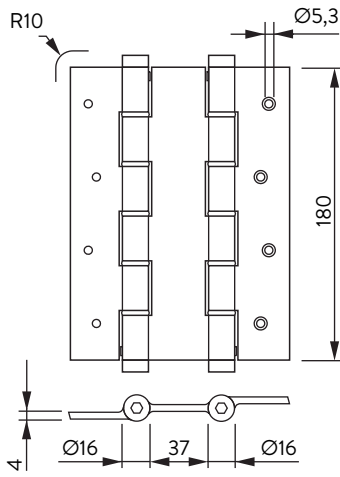
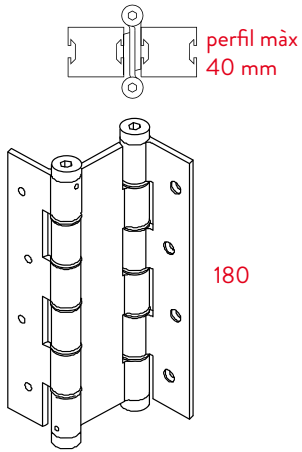

**DA A**  
180

