

# DAW ALUM

DAW 120 / DAW 180 / DAW A 180

Cerniera per porte a vento per installazione diretta a parete o cornice della porta, richiede solo la fresatura della porta senza controtelaio. Riduce fino al 50% il tempo di assemblaggio rispetto a quello di una cerniera a vento convenzionale.

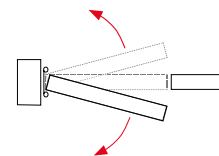

### Materiali esterni

- bandella: alluminio anodizzato
- tappo regolazione: zamac
- rondelle: poliammide

### Materiali interni

- asse all'interno: acciaio inox AISI 304
- molla interna: set lamiera d'acciaio (180) o acciaio al carbonio (120) con grasso protettore

### Funzionamento

- applicazione: adatto per porte interne/esterno
- ritorno automatico: sì
- regolatore di potenza: sì
- apertura massima: 180°
- cicli: più di 500.000

### Corretta installazione 2 e 3 cerniere

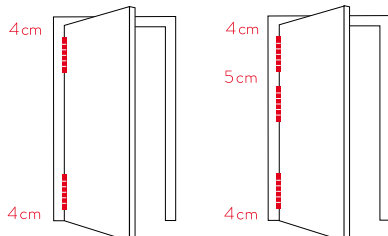

### Tensione

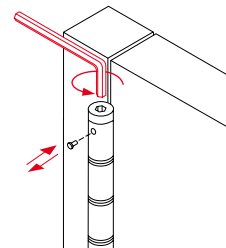

### Installazione senza controtelaio

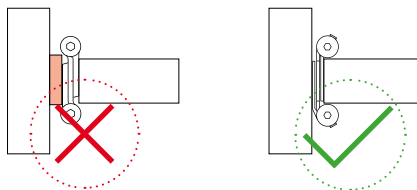

3 punti di tensione

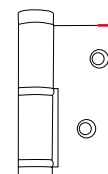

bordo dritto

## DAW 120

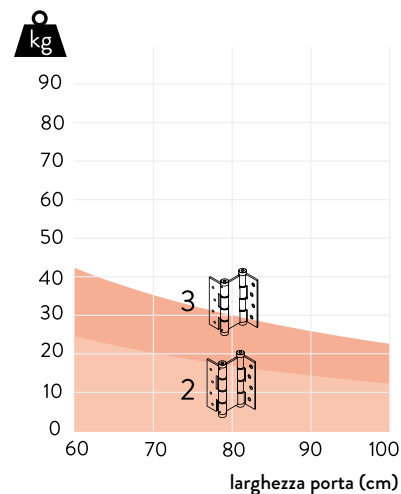
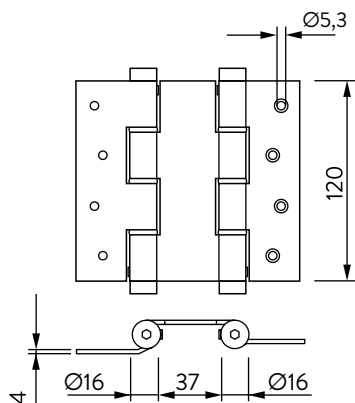
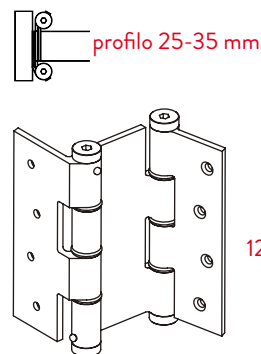

DAW doppia azione

### DAW 180

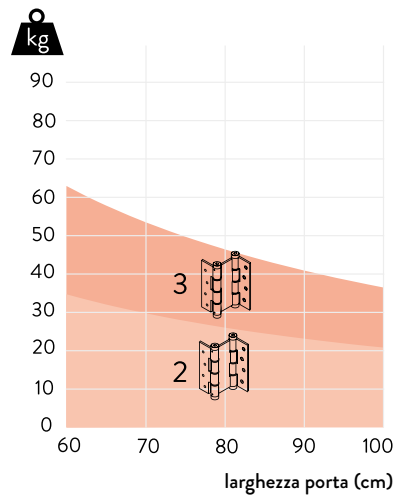
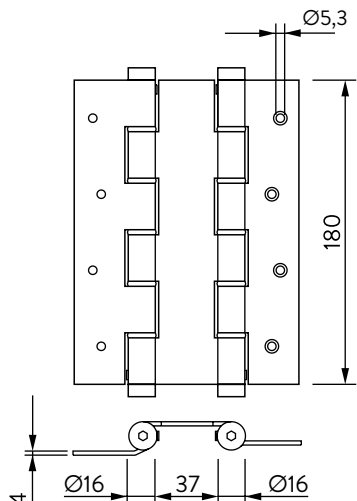
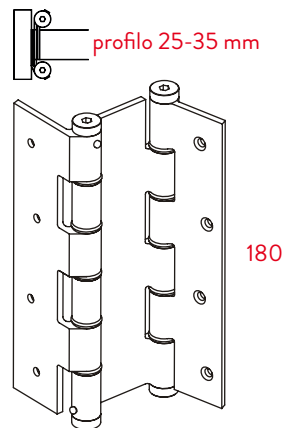

### DAW A 180

