

since
1946

talleres
trepat

hinges and
paumelles



 **Justor**



VINCA
INDUSTRIAL

S Tm

index

 **Justor**

1 | introduction

- pp-
- 6 who are we
- 10 solutions
- 12 common considerations

3 | single action

SA series

- AL
- pp-
- 32 SA 120 / 180
- SST
- 34 SA 120 / 180
- IRON
- 36 SA 120 / 180

ST series

- AL
- pp-
- 38 STW 150 / STC 150
- SST
- 40 STW 150 / STC 150

SF series

- AL
- pp-
- 42 SF 120

5 | data sheet

- pp-
- 66 DA / DP
- 68 SA / ST / SF
- 69 MB / MP / PM / PF / MZ
- 70 PG / PP / PPM

2 | double action

DA series

- AL
- pp-
- 18 DA 120 / 180
- 20 DAW 120 / 180
- 22 DA R40 180
- SST
- 24 DA 120 / 180
- IRON
- DA 120 / 180

DP series

- AL
- pp-
- 28 DP 120

4 | spring hinge

- AL
- pp-
- 46 MB
- 48 MP
- 50 PM
- 52 PF
- 54 MZ
- SST / IRON
- 56 PG washer
120/180/240
- 58 PG bearing
180CR/240CR/240CRP
- IRON
- 60 PP
- 62 PPM
240CR/240CRP

6 | codes

- pp-
- 74 - 75 DA / DP
- 75 - 76 SA / ST / SF
- 76 - 77 MB / MP / PM / PF / MZ
- 77 PG / PP / PPM



A company formed by a team
whose mission is to manufacture
all **Justor** products with the
highest quality and warranty



Objective: quality assurance, prestige and brand pride

The **Justor** spring hinges are fittings designed to ensure smooth automatic closing of all types of doors, windows, covers, etc.

Designed in **aluminum, stainless steel, iron and/or plastic**, our wide range of products offers solutions for single acting doors as well as double acting doors (swing doors).

With a distinguished **spring system** consisting of a set of **blades** working by torsion, lifetime of these products can reach up to 500.000 opening and closing cycles. The strength of the spring is always adjustable and the loading capacity of these products can be up to 250 kg, depending on chosen product and finishing.



Solutions for all types of doors

10

Manufacturers since 1946, our spring hinges are sold in over 70 countries. The reason for this success is that we meet the **different needs** demanded in such diverse industries as metal, wood, food, health, aeronautics, etc. and in all types of indoor and outdoor architecture projecting today.

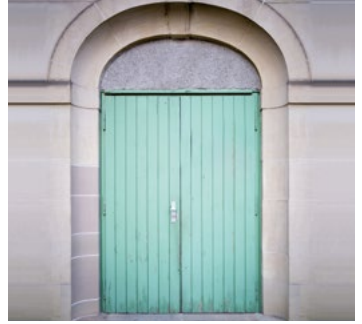

11



Common considerations for all hinges

aluminum



silver .01



gold .02

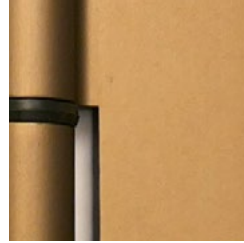

bronze .03



white .06

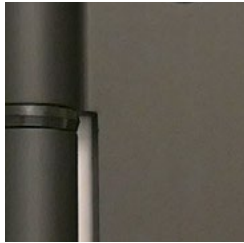

black .09



F6 finishing .94



bright brass . 04

All our hinges are available with and without spring.

All our models can be produced in any RAL color as required.

stainless steel



sst AISI 304 .05



sst AISI 316 .35

iron



zinc-plated iron .08

proper installation of 2 and 3 hinges

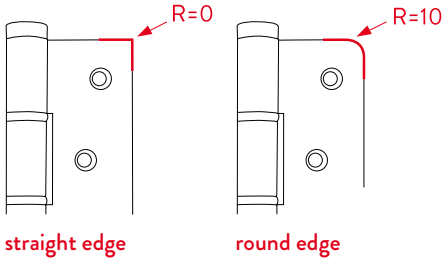
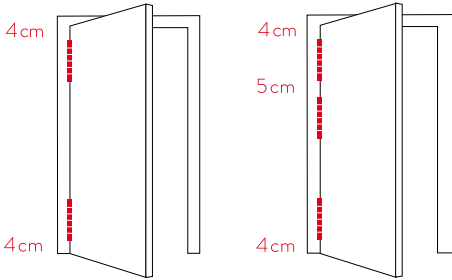

packaging



maintenance

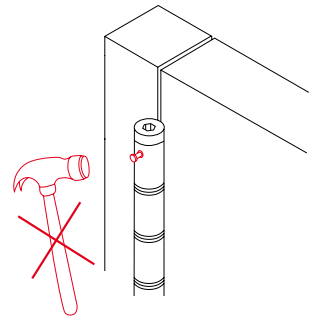
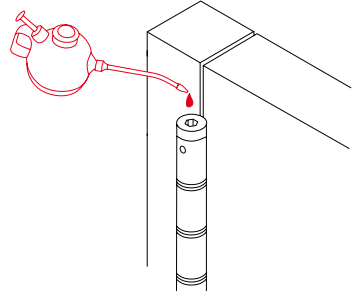

tension

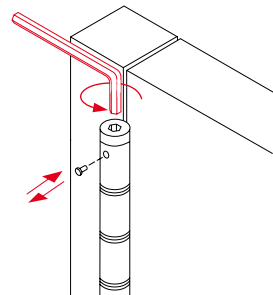

cap

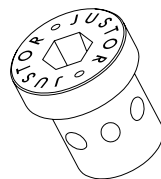

Common considerations for all hinges

spring system

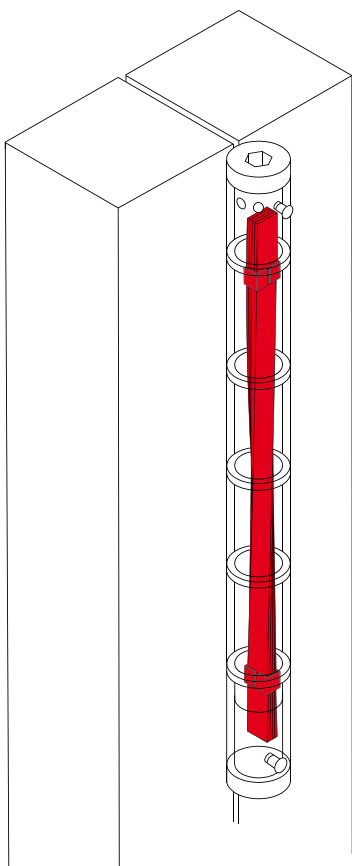

Our spring system is composed of a set of blades that works by torsion and underlies the high performance of our spring hinges.

Either **iron** or **stainless steel**, the quality of material used in its manufacturing, its high resistance to breakage and deformation and its optimum elasticity makes a big difference on the market between a **Justor** spring hinge and a normal spring hinge.

Until today there isn't an equal spring system used to assemble spring hinges, this is a very important fact because this element is what really determines the door weight capacity, as well as the opening/closing cycles, namely, the lifetime cycles of the product.

easy adjustment

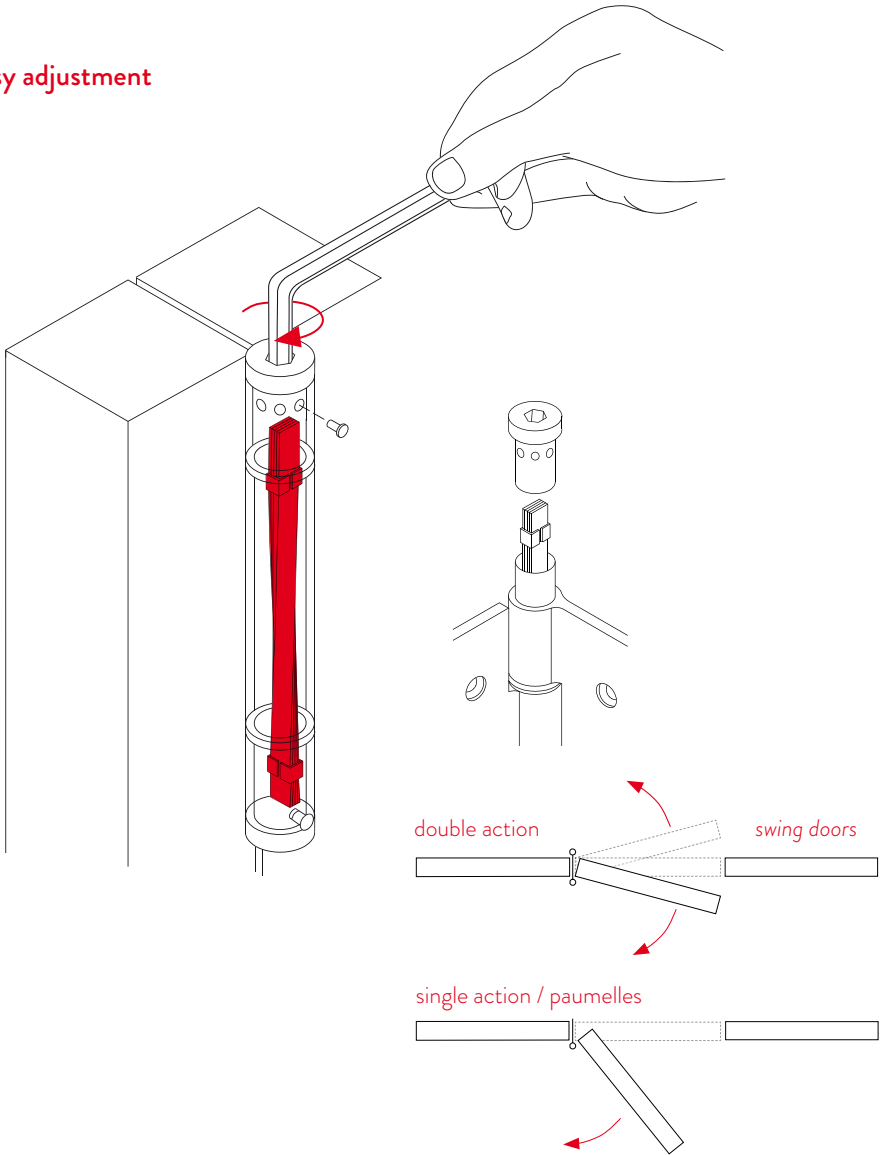

double action

for swing doors

 **Justor**

DA series

AL

PP-

- 18 DA 120 DA 180 The widest range for the aluminum and wood professional.
- 20 DAW 120 DAW 180
- 22 DA R40 180

SST

PP-

- 24 DA 120 DA 180 Prepared for the most demanding situations, offering a high resistance to intensive use.

IRON

PP-

- 26 DA 120 DA 180 New applications to give solutions in new markets.

DP series

AL

PP-

- 28 DP 120 A unique and surprising innovation for light double action doors.

aluminum

double action
DA series

DA 120
DA 180





DA double action

DA 120 DA 180

Hinges for swing doors, conceived for a lot of transit. Available in 3 different widths, 30 mm, 40 mm and 50 mm (only DA 180 model), they provide a solution to any need.



Uses

Clinic and hospital doors, industrial and design kitchens, interior entries to warehouses and shops in general.

Features

For wooden and aluminum doors. Spring resistance 500.000 opening and closing cycles. Available in silver, gold, bronze, white and black. Possibility of manufacturing in other colors. Finishings with straight edge (90°) and round edge (R=10).

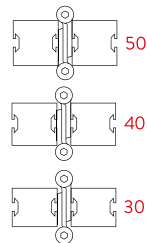
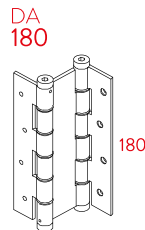
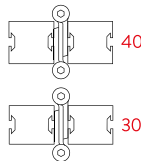
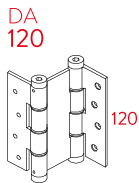

aluminum

double action
DA series

DAW 120
DAW 180

20





DA double action

DAW 120 DAW 180

Hinge designed for direct mounting on frame or wall, without milling or rebating. **It reduces up to 50% assembly time compared to a conventional spring hinge.**



Uses

Especially suitable in applications for woodwork in restoration and interior architecture.

Features

Exclusively available in anodized aluminum, finishing in various colors. High resistant polyamide washers, zamak chrome or black cap (depending on model) and galvanized steel pins. DAW 180 model available in 2 different widths, 25-35 mm and 35-45 mm. Adjustable closing power and high loading capacity. More than 500.000 lifecycles.

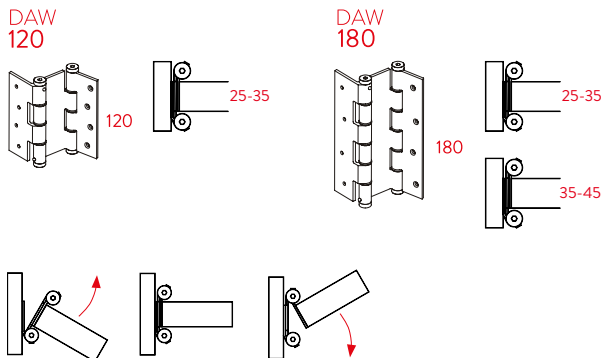

aluminum

double action
DA series

DA R40 180



AL

DA double action

DA R40 180

Specifically made for the aluminium market, this hinge adapts perfectly to all kinds of swing doors with R40 profile. This is possible thanks to the specific design of each of its blades, which facilitates its fitting within the profile itself, achieving an almost perfect functioning.



Uses

Sports facilities, exhibition centers, pharmaceutical laboratories and spray booths.

Features

3-points of force intensity, easily adjustable. Optimal work efficiency with 2 hinges assemblies, as well as 3 hinges installations. Load capacity up to 65 kg.

DA R40 180

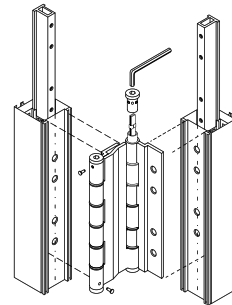
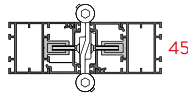
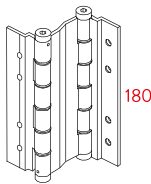

stainless steel

double action
DA series

DA 120
DA 180

24





DA double action

DA 120 DA 180

Prepared to work in especially harsh environments. Available in stainless steel **AISI 304** and **AISI 316** stainless steel, better known as “Marine Steel”.



Uses

Coastal facilities, nautical industry, saline environments, food industry and livestock sector among others.

Features

Polished stainless steel, sintered caps and washers **AISI 316**, pins and inner shaft **AISI 304**. Stainless steel inside leaf spring **AISI 301**, covered with corrosion protective grease, especially suitable for marine environments. DA 180 available in 2 different widths, 40 mm and 50 mm.

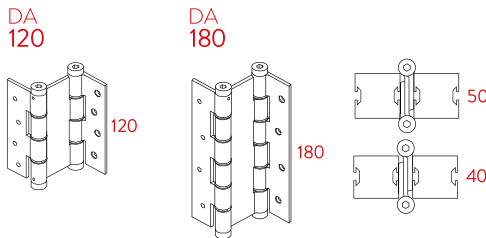

iron

double action
DA series

DA 120
DA 180

26



IRON

DA double action

DA 120 DA 180

Hinge prepared for traditional installation to be fixed with screws, as well as for installation by welding on frame and door.



Uses

Accesses to transport machinery, internal factories passages and metal industry in general.

Features

Finish in galvanized steel. Force adjustment with pin. Maximum performance even with minimum tension. Capacity up to 20 kg per hinge (see application table).

DA
120

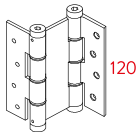

DA
180

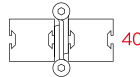
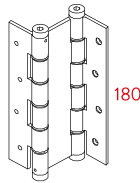



AL

DA double action

DP 120

Double action spring hinge for swinging doors. Easy and fast installation. It is installed directly without milling frame or door.



Uses

Light doors to access pharmacy counters, bars or other food and catering stores.

Features

It allows to dismantle the door without having to unscrew the pin. Just 2,7 mm thick. Load capacity up to 20 kg. Double action spring hinge 120 mm length, 3 possible tension points of the inner spring. Available in aluminum in silver, gold, bronze, white and black finish.

DP
120

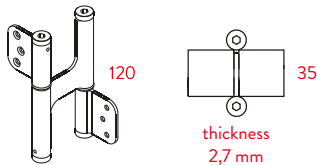

single action

 **Justor**

SA series

AL

PP-

32 SA 120
SA 180

Made from lightweight quality materials, high load capacity guaranteed.

SST

PP-

34 SA 120
SA 180

Different qualities to satisfy every need.

IRON

PP-

36 SA 120
SA 180

Solutions in new materials for new applications.

SF series

AL

PP-

42 SF 120

Same quality, redesigned for new applications.

ST series

AL

PP-

38 STW 150
STC 150

A new concept for spring hinges, installation without mortising.

SST

PP-

40 STW 150
STW 150

Prepared for outdoor installations, presenting a compact and innovative design.

aluminum

single action
SA series

SA 120
SA 180

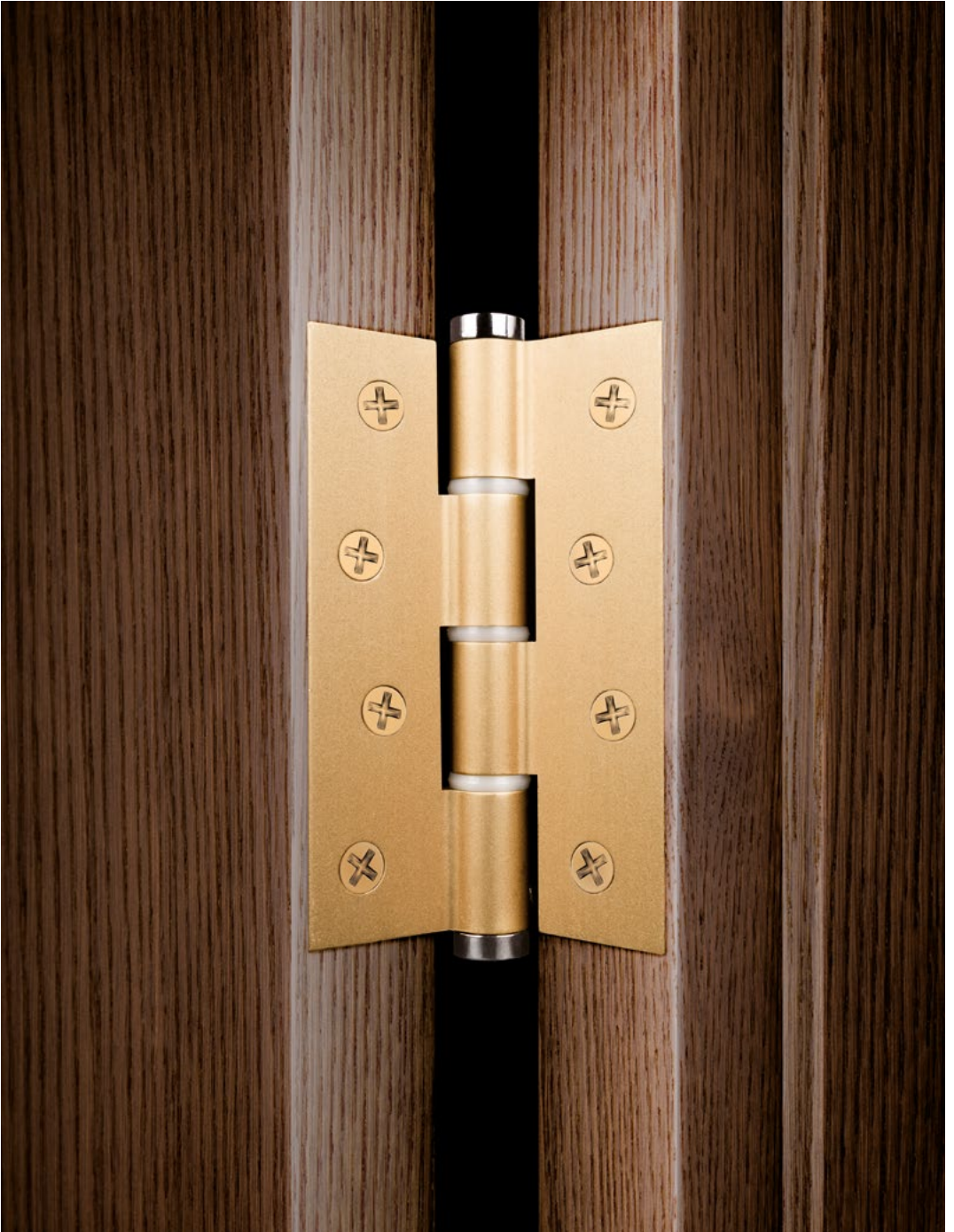

AL

SA single action

SA 120 SA 180

Hinge for wooden and aluminum doors. Closing strength adjustable with multipoint cap.

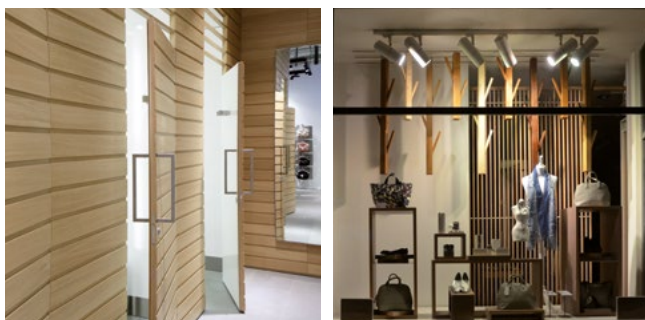

Uses

Suitable for entries requiring immediate closing, especially when it isn't possible to install a traditional hydraulic door closer.

Features

Made of anodized aluminum. Four fixation points on each blade. Finishing with straight edge or round edge. Can be manufactured in any RAL colors on demand.

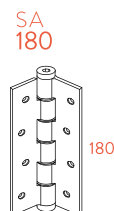
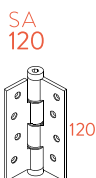



SST

SA single action

SA 120 SA 180

Specially prepared for outdoor use, in damp and/or saline environment. Shaft protected with anti corrosion grease. Allows door opening to 180°.



Uses

Hotel rooms, locker rooms, accesses to boat docks, facilities in chemical and pharmaceutical industry as well as any type of marine environment.

Features

Hinge made of stainless steel AISI 304 or stainless steel AISI 316. Polish treatment. Sintered caps and washers, always in stainless AISI 316.

SA
120

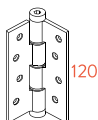

SA
180

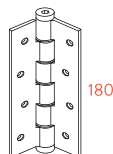

iron

single action
SA series

SA 120
SA 180

36





SA single action

SA 120 SA 180

It allows installation by welding providing the same performance as by fixing with screws. The steel hinges provide the same work performance as the aluminum or stainless steel hinges.



Uses

Pedestrian accesses, private homes, boiler works, external fencing, metal constructions, forge works.

Features

Galvanized Steel. Easy strength adjustment. High load capacity. 3 mm thick blades. Minimum of 500.000 working cycles.

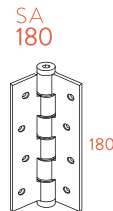
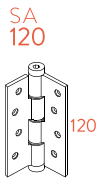

aluminum

single action
ST series

STW 150
STC 150





ST series

STW STC 150 150

Hinges with a special design, where the blade works inside the other blade, providing exceptional thinness, no need to rebate.

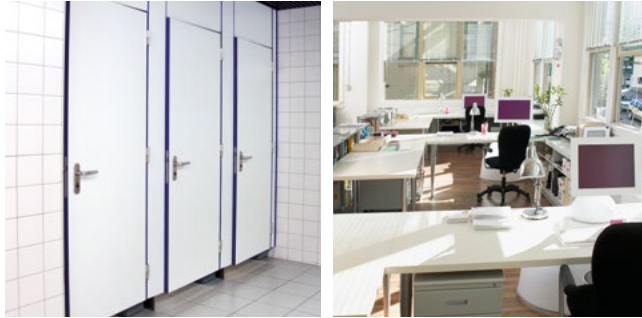

Uses

Any type of light interior doors like offices, archives, cabinets...

Features

In the **STW** version, the blades are displaced from the axis of the hinges, allowing direct installation to any surface without sub frame.

STC version has two different blade lengths, providing solutions to existing frameworks in different thicknesses.

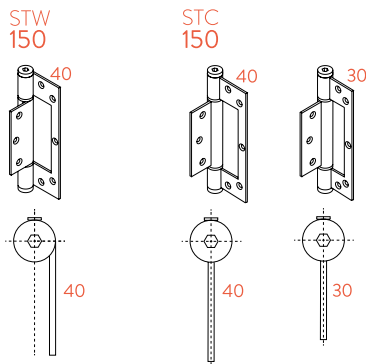



SST

ST series

STW STC 150 150

Spring hinges made of stainless steel AISI 304. Just 2,5 mm thick. Respects the natural space between frame and door. **Reduces assembly time since it can be installed directly without milling frame or door.**



Uses

Interior design, sports facilities, health centers and food industry.

Features

Stainless steel AISI 304. Lower axis fixed. Washers and pins in marine AISI 316. Adjustable closing strength.

STW
150

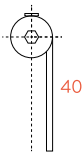
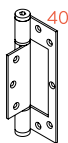

STC
150

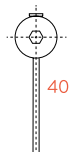
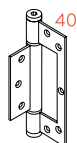

30

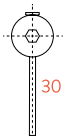
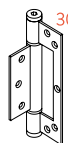



AL

SF SF series

SF 120

Overlapping single action hinge, specially indicated for installations in phenolic and/or similar materials.

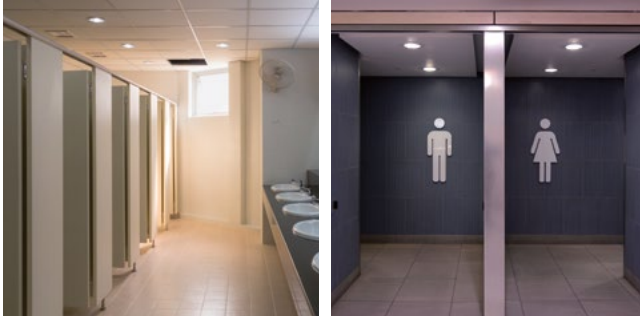

Uses

Doors in exhibition stands, fencing doors, call centres.

Features

Available in aluminum, presented in various colors. Round edge finish. Total length of only 120 mm. Load capacity up to 40 kg. More than 300.000 opening and closing cycles.

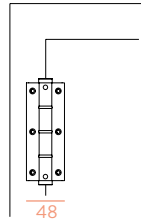
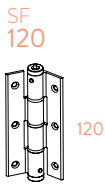

spring hinge

 **Justor**



AL

spring hinge

MB

spring arm

MB

Easy installable product. Possibility to easily enable or disable spring function.



Uses

Bathroom doors, storage rooms, stores and interior doors in general.

Features

Easy adjustable spring strength. Endurance of more than 250.000 work cycles. Aluminum finishing in various colors. Special model for outdoor installation.

MB

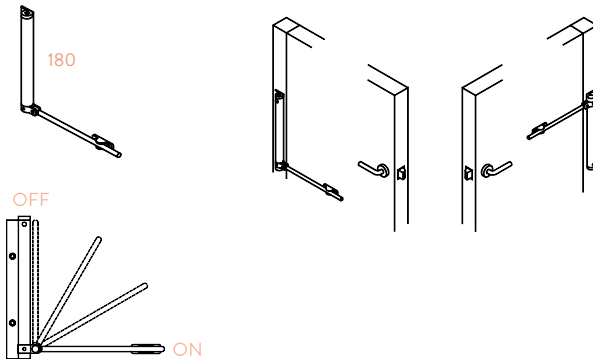





MP spring hinge

spring hinge MP

Perfect for installation as third hinge on doors, in order to close the door automatically.



Uses

Wardrobe doors, changing rooms, offices and others.

Features

Complementary product on doors with already-existing hinges. Pushes doors up to 40 kg. More than 200.000 work cycles. Anodized aluminum finishing and presented in blister package. To be installed at the center of the door allowing an automatic closure.

MP

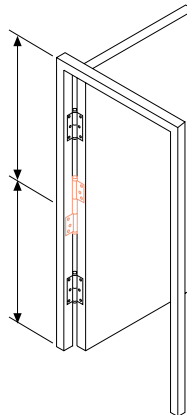
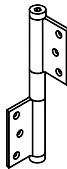

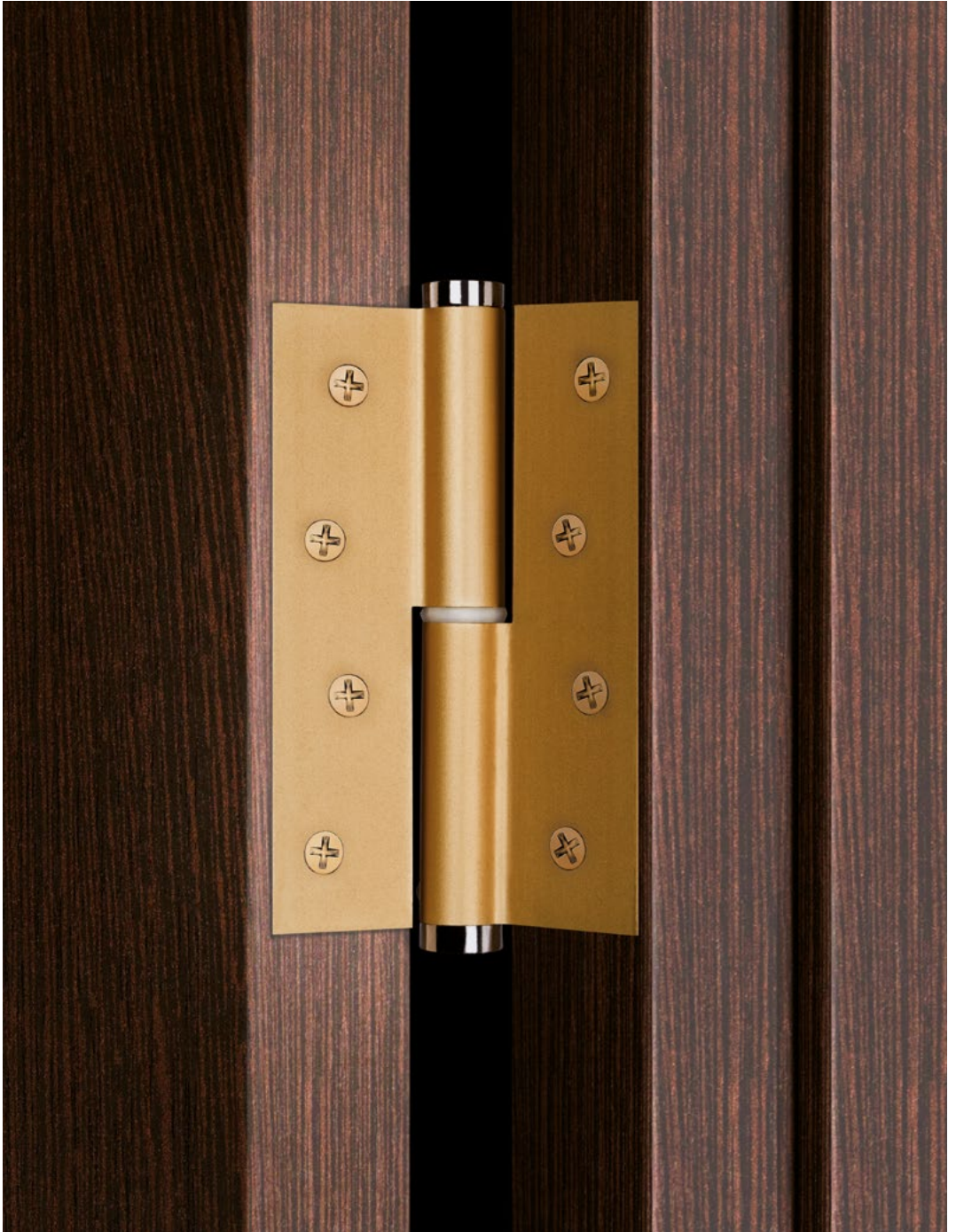



spring hinge

PM

spring loaded paumelle PM

For wooden doors. Makes installation easier, not necessary to unscrew the hinges if removing the door is necessary at any given time.



Uses

Cottages, apartments, hotels, schools and convention centers.

Features

Made of aluminum exclusively for woodwork. 120 mm length. For interior doors. Load capacity up to 20 kg. Available in left and right models according to installation.

PM

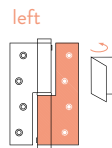
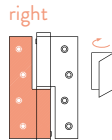
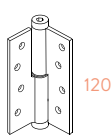



AL

PF spring hinge

frontal paumelle

PF

Especially suitable for installations on phenolic materials or similar, this overlapping single action spring hinge allows to remove the door easily.

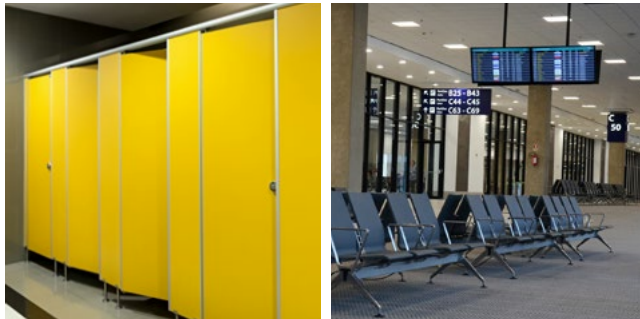

Uses

Doors in public services, changing rooms, showers in campsites and sports centers.

53

Features

The total length of the product is 90 mm. More than 250.000 work cycles. Available in aluminum (silver finish, gold, bronze, white or black). Load capacity up to 15 kg.

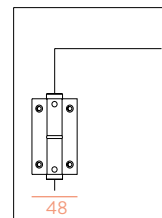
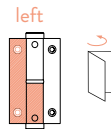
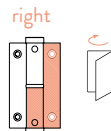
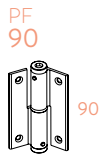

aluminum
plastic

spring hinge

MZ AL
MZ PL

54



AL

PLAS

PF
spring hinge

MZ MZ
AL PL

Screen door hinge. Ensures automatic closure of this type of auxiliary door, preventing any unwanted insects.



Uses

Private homes, cottages, hostels.

Features

Made of aluminum for wooden doors and high-resistance plastic for aluminum doors. The aluminum hinge comes in different color finishes, while the plastic one comes in black color. The load capacity is up to 5 kg. It comes in boxes of 20 units or blister package of 2 units.

MZ

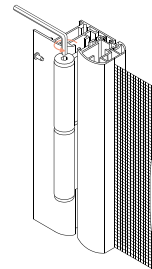
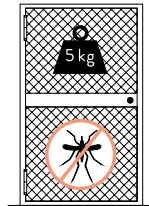
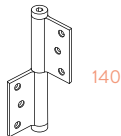

stainless steel
iron

spring hinge

PG 120
PG 180
PG 240

56



IRON

SST

PG spring hinge

Drop Hinge with washer

PG PG PG
120 180 240

Hinges with washer and drop profile for installation on doors by welding. Made of steel or stainless steel. High resistance to deformation.



Uses

Auxiliary doors, garage doors, pre-access doors of communities or heavy duty doors.

Features

12 mm drop profile. It comes in 120 mm, 180 mm and 240 mm length. Supplied with washer. Capacity of a basic installation with two hinges ranging from 20 kg to 60 kg. The stainless steel version is AISI 304. Pins and washer in AISI 316.

PG
120



120

PG
180

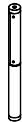

180

PG
240



240



stainless steel
iron

spring hinge

PG 180 CR
PG 240 CR
PG 240 CRP

58



IRON

SST

PG spring hinge

Drop Hinge with bearing

PG 180 CR PG 240 CR PG 240 CRP

Hinges with smooth opening and closing actuation due to bearing on the central axis, instead of washer, which practically doubles its capacity.

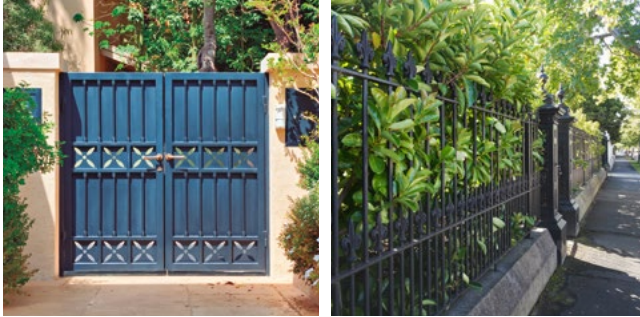

Uses

Gate fences, furnaces, private gardens, doors of industrial lifts, exterior architecture in stainless steel.

Features

Made of steel or stainless steel. It comes in 180 mm and 240 mm length. High load capacity, for doors up to 250 kg in weight. Components are manufactured in stainless steel AISI 304 and AISI 316, offering high corrosion resistance.

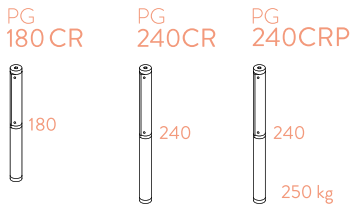

60





PP spring hinge

Blade Hinge with washer

PP 240

Hinge built with 2 steel profiles. The upper pushes the door, by working on the lower washer, which is welded to the frame.



Uses

Warehouse doors, spray cabins, livestock accesses, fencing accesses.

Features

Pushes, but does not carry the weight of the door. Single length of 240 mm. High resistance to deformation. 3 positions adjustable force. Opening up to 180°.

PP 240

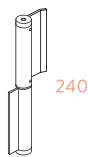



IRON

spring hinge

PPM CR

Blade Hinge with bearing

PPM 240 CR PPM 240 CRP

Blade hinges with bearing for installation on doors by screwing. Smooth opening and closing thanks to the bearing on the central axis.



Uses

Heavy doors mainly wooden. Fences, gates, industry, sports centers, etc.

Features

Same hinge for left and right opening. 2 different models available. Single length of 240 mm in both models. Load capacity up to 150 kg (CRP model). Made of zinc-plated steel.

PPM 240

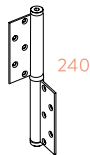

data sheet

 **Justor**

PP:

66 DA / DP

68 SA / ST / SF

69 MB / MP / PM / PF / MZ

70 PG / PP / PPM

DA / DP double action

for swing doors

66

DA E al 180

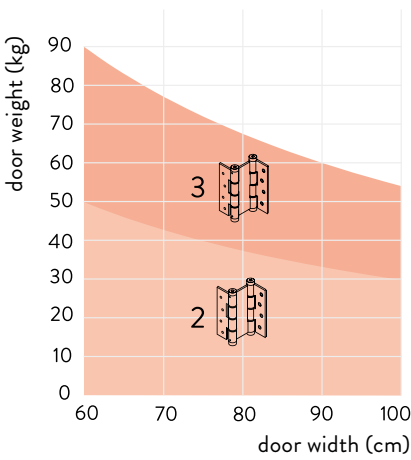

DA al 180 DA sst 180 DA iron 180

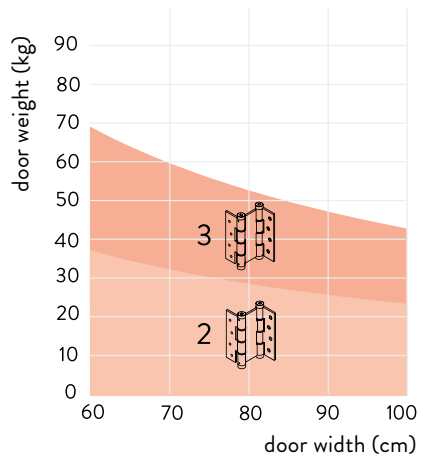

DA A al 180 DA A sst 180 DAW al 180 DA R40 al 180

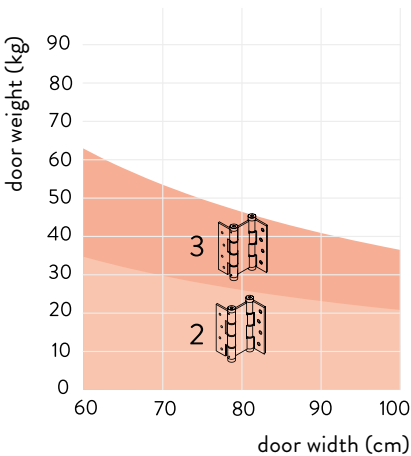

DA E al 120 DAW A al 180

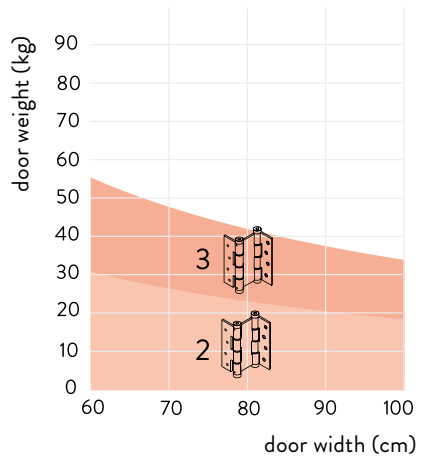

DA al 120
DA sst 120
DA iron 120
DAW al 120

assembly
video DA

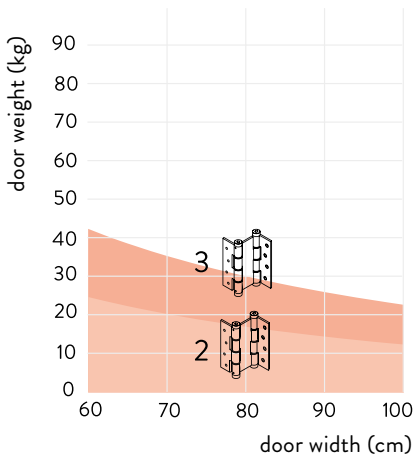

DP al 120

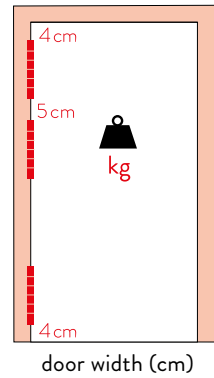
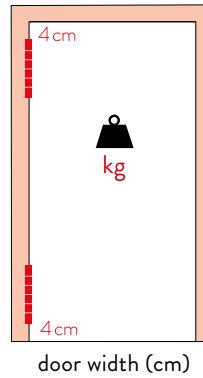
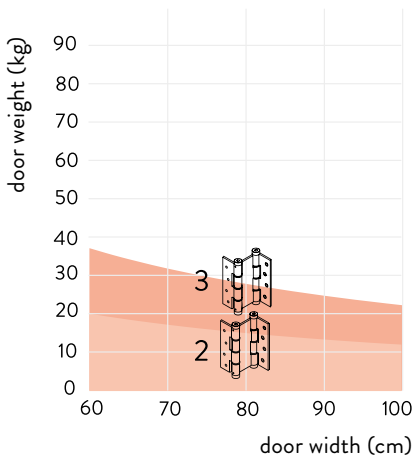

SA / ST / SF single action

assembly
video ST

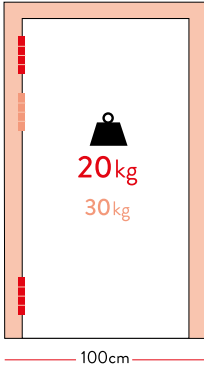

SA al 120
SA sst 120
SA iron 120

installation
2 hinges
installation
3 hinges

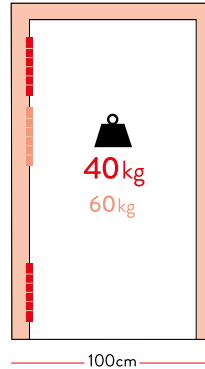

SA al 180
SA sst 180
SA iron 180

installation
2 hinges
installation
3 hinges

68

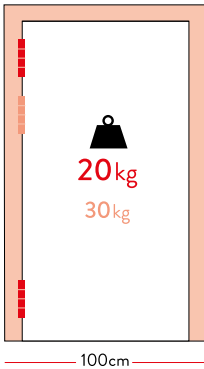

STW al 150
STC al 150

installation
2 hinges
installation
3 hinges

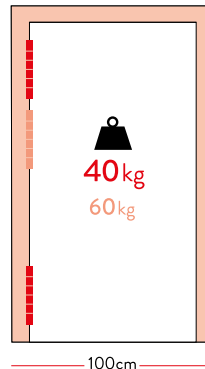

STW sst 150
STC sst 150

installation
2 hinges
installation
3 hinges



SF al 120

installation
2 hinges
installation
3 hinges

aluminum

ø16



sst 120

ø17



sst 180

ø18



iron 120

ø17



iron 180

ø18



MB/MP/PM/PF/MZ spring hinges

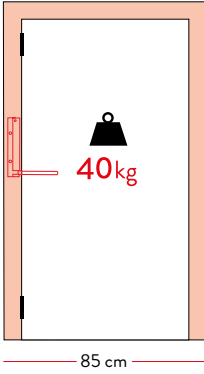

MB al

installation
1 hinge

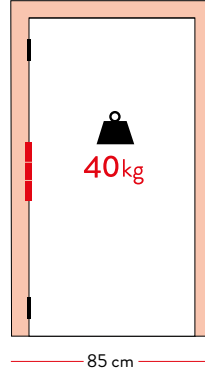

MP al

installation
2 hinges

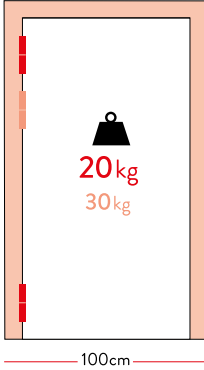

PM al

installation
2 hinges
installation
3 hinges

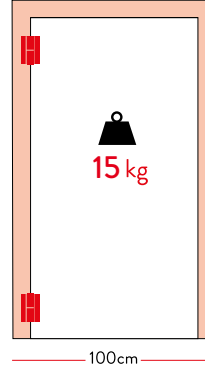

PF al 90

installation
2 hinges

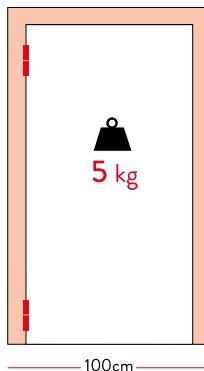

MZ al
MZ plastic

installation
2 hinges



PG spring hinge

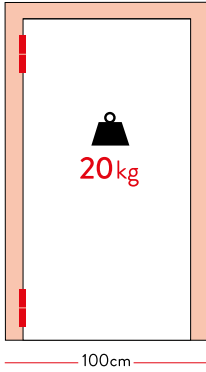

PG 120 sst
PG 120 iron

installation
2 hinges

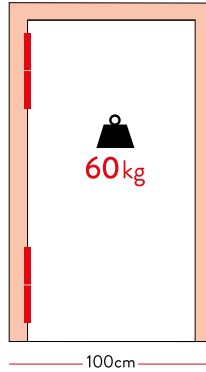

PG 180 CR sst
PG 180 CR iron

installation
2 hinges

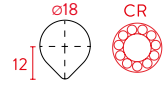

70

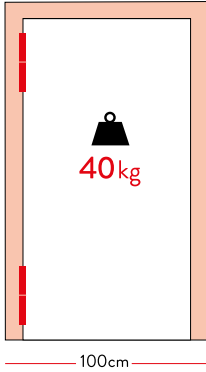

PG 180 sst
PG 180 iron

installation
2 hinges

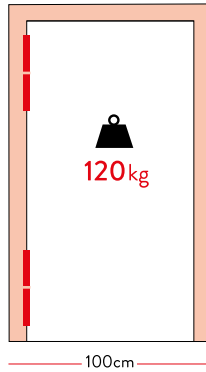

PG 240 CR sst
PG 240 CR iron

installation
2 hinges

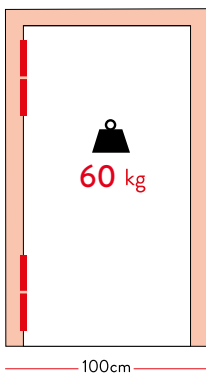
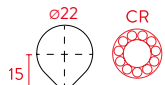

PG 240 sst
PG 240 iron

installation
2 hinges

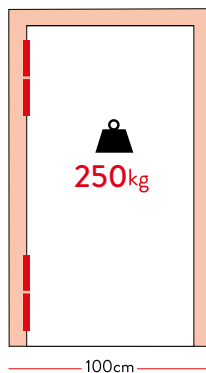

PG 240 CRP sst
PG 240 CRP iron

installation
2 hinges

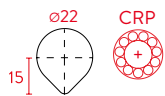

PP/PPM spring hinge

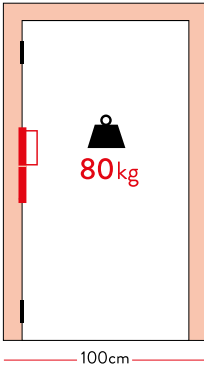

PP 240 iron

installation
1 hinge

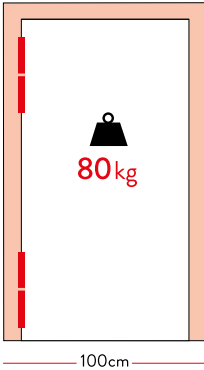
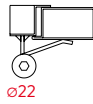

PPM 240 CR iron

installation
2 hinges

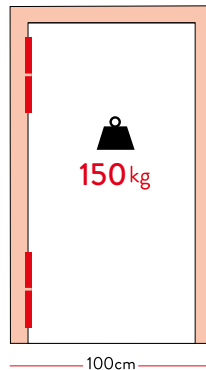

PPM 240 CRP iron

installation
2 hinges



codes

codes

○ Justor

PP-
74 - 75 DA / DP
75 - 76 SA / ST / SF
76 - 77 MB / MP / PM / PF / MZ
77 PG / PP / PPM

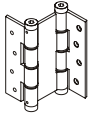

Double action hinge DA 120

Packaging: 15 units box /
20 units blister

			Box (x2)	Blister (x1)
DA 120		DA 120 Silver	5414.01	5413.01
		Gold	5414.02	5413.02
		Bronze	5414.03	5413.03
		Gold brass	5414.04	5413.04
		White	5414.06	5413.06
		Black	5414.09	5413.09
		F6	5414.94	5413.94
		Special	5414.99	5413.99
		SST	5414.05	5413.05
		SST 316	5414.35	5413.35

Iron zinc-plated 5414.08 -

DA 120 R		DA 120 R Silver	5414.21	5413.21
		Gold	5414.22	5413.22
		Bronze	5414.23	5413.23
		Gold brass	5414.24	5413.24
		White	5414.26	5413.26
		Black	5414.29	5413.29
		SST	5414.25	5413.25

DA 120 Narrow		DA 120 Narrow Silver	5404.01	5403.01
		Gold	5404.02	5403.02
		Bronze	5404.03	5403.03
		Gold brass	5404.04	5403.04
		White	5404.06	5403.06
		Black	5404.09	5403.09
		F6	5404.94	5403.94
Special	5404.99	5403.99		

DA 120 R Narrow		DA 120 R Narrow Silver	5404.21	5403.21
		Gold	5404.22	5403.22
		Bronze	5404.23	5403.23
		Gold brass	5404.24	5403.24
		White	5404.26	5403.26
		Black	5404.29	5403.29

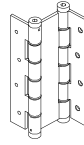

Double action hinge DA 180

Packaging: 15 units box /
20 units blister

			Box (x2)	Blister (x1)
DA 180		DA 180 Silver	5914.01	5913.01
		Gold	5914.02	5913.02
		Bronze	5914.03	5913.03
		Gold brass	5914.04	5913.04
		White	5914.06	5913.06
		Black	5914.09	5913.09
		F6	5914.94	5913.94
		Special	5914.99	5913.99
		SST	5914.05	5913.05
		SST 316	5914.35	5913.35

Iron zinc-plated 5914.08 -

DA 180 R		DA 180 R Silver	5914.21	5913.21
		Gold	5914.22	5913.22
		Bronze	5914.23	5913.23
		Gold brass	5914.24	5913.24
		White	5914.26	5913.26
		Black	5914.29	5913.29
		SST	5914.25	5913.25

DA 180 Narrow		DA 180 Narrow Silver	5904.01	5903.01
		Gold	5904.02	5903.02
		Bronze	5904.03	5903.03
		Gold brass	5904.04	5903.04
		White	5904.06	5903.06
		Black	5904.09	5903.09
		Special	5904.94	5903.94

DA 180 R Narrow		DA 180 R Narrow Silver	5904.21	5903.21
		Gold	5904.22	5903.22
		Bronze	5904.23	5903.23
		Gold brass	5904.24	5903.24
		White	5904.26	5903.26
		Black	5904.29	5903.29

DA 180 Wide		DA 180 Wide Silver	5934.01	-
		Gold	5934.02	-
		Bronze	5934.03	-
		Gold brass	5934.04	-
		White	5934.06	-
		Black	5934.09	-
		Special	5934.94	-

SST 5934.05 -

DA 180 R Wide		DA 180 R Wide Silver	5934.21	-
		Gold	5934.22	-
		Bronze	5934.23	-
		Gold brass	5934.24	-
		White	5934.26	-
		Black	5934.29	-

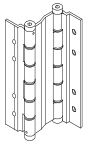

Double action hinge DA R40

Packaging: 15 units box

		Box (x2)	
DA R40	DA R40	Silver	R- 5934.01 -
		Gold	R- 5934.02 -
		Bronze	R- 5934.03 -
		Gold brass	R- 5934.04 -
		White	R- 5934.06 -
		Black	R- 5934.09 -
		Special	R- 5934.99 -

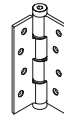

Single action hinge SA 120

Packaging: 20 units box / 25 units blister

		Box (x2)	Blister (x1)
SA 120	SA 120	Silver	5314.01 5313.01
		Gold	5314.02 5313.02
		Bronze	5314.03 5313.03
		Gold brass	5314.04 5313.04
		White	5314.06 5313.06
		Black	5314.09 5313.09
		F6	5314.94 5313.94
		Special	5314.99 5313.99
		SST	5314.05 5313.05
		SST 316	5314.35 5313.35

		Box (x2)	Blister (x1)
SA 120 R	SA 120 R	Silver	5314.21 5313.21
		Gold	5314.22 5313.22
		Bronze	5314.23 5313.23
		Gold brass	5314.24 5313.24
		White	5314.26 5313.26
		Black	5314.29 5313.29
		SST	5314.25 5313.25

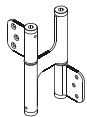

Double action hinge DP 120

Packaging: 15 units box / 20 units blister

		Box (x2)	Blister (x1)
DP 120	DP 120	Silver	6014.01 6013.01
		Gold	6014.02 6013.02
		Bronze	6014.03 6013.03
		Gold brass	6014.04 6013.04
		White	6014.06 6013.06
		Black	6014.09 6013.09
		Special	6014.99 6013.99

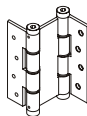

Double action hinge DAW

Packaging: 15 units box / 20 units blister

		Box (x2)	Blister (x1)
DAW 120	DAW 120	Silver	6414.01 6413.01
		Gold	6414.02 6413.02
		Bronze	6414.03 6413.03
		Gold brass	6414.04 6413.04
		White	6414.06 6413.06
		Black	6414.09 6413.09
		Special	6414.99 6413.99



DAW 180	DAW 180	Silver	6914.01 6913.01
		Gold	6914.02 6913.02
		Bronze	6914.03 6913.03
		Gold brass	6914.04 6913.04
		White	6914.06 6913.06
		Black	6914.09 6913.09
	Special	6914.99 6913.99	



DAW 180 Wide	DAW 180 Wide	Silver	6934.01 -
		Gold	6934.02 -
		Bronze	6934.03 -
		Gold brass	6934.04 -
		White	6934.06 -
		Black	6934.09 -
		Special	6934.99 -

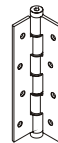

Single action hinge SA 180

Packaging: 20 units box / 25 units blister

		Box (x2)	Blister (x1)
SA 180	SA 180	Silver	5814.01 5813.01
		Gold	5814.02 5813.02
		Bronze	5814.03 5813.03
		Gold brass	5814.04 5813.04
		White	5814.06 5813.06
		Black	5814.09 5813.09
		F6	5814.94 5813.94
		Special	5814.99 5813.99
		SST	5814.05 5813.05
		SST 316	5814.35 5813.35

Iron zinc-plated 5814.08 -

SA 180 R	SA 180 R	Silver	5814.21 5813.21
		Gold	5814.22 5813.22
		Bronze	5814.23 5813.23
		Gold brass	5814.24 5813.24
		White	5814.26 5813.26
		Black	5814.29 5813.29



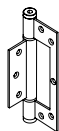

SST 5814.25 5813.25



Single action hinge STC

Packaging: 20 units box /
25 units blister

			Box (x2)	Blister (x1)
STC 150		STC Silver	6364.01	6363.01
		Gold	6364.02	6363.02
		Bronze	6364.03	6363.03
		Gold brass	6364.04	6363.04
		White	6364.06	6363.06
		Black	6364.09	6363.09
		Special	6364.99	6363.99
	SST	6364.05	6363.05	

STC 150		STC Silver	6354.01	6353.01
		Gold	6354.02	6353.02
		Narrow Bronze	6354.03	6353.03
		Gold brass	6354.04	6353.04
		White	6354.06	6353.06
		Black	6354.09	6353.09
		Special	6354.99	6353.99
SST	6354.05	6353.05		



Single action hinge STW

Packaging: 20 units box /
25 units blister

			Box (x2)	Blister (x1)
STW 150		STW Silver	6314.01	6313.01
		Gold	6314.02	6313.02
		Bronze	6314.03	6313.03
		Gold brass	6314.04	6313.04
		White	6314.06	6313.06
		Black	6314.09	6313.09
		Special	6314.99	6313.99
SST	6314.05	6313.05		

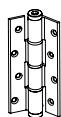

Single action hinge SF

Packaging: 20 units box

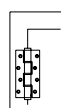
			Box (x2)	Blister (x1)
SF 120		SF Silver	5114.01	5113.01
		Gold	5114.02	5113.02
		Bronze	5114.03	5113.03
		Gold brass	5114.04	5113.04
		White	5114.06	5113.06
		Black	5114.09	5113.09
		Special	5114.99	5113.99

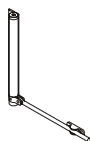

Spring arm MB 180

Packaging: 25 units blister

			Blister (x1)
MB 180		MB Silver	- 5613.01
		Gold	- 5613.02
		Bronze	- 5613.03
		White	- 5613.06
		Black	- 5613.09
		Special	- 5613.99
		Exterior (Black)	- 5613.85

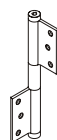

Spring hinge MP 180

Packaging: 25 units blister

			Blister (x1)
MP 180		MP Silver	- 5713.01
		Gold	- 5713.02
		Bronze	- 5713.03
		Gold brass	- 5713.04
		White	- 5713.06
		Black	- 5713.09
		F6	- 5713.94
		Special	- 5713.99

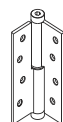

Spring hinge PM 120

Packaging: 20 units box /
25 units blister

			Box (x2)	Blister (x1)
PM 120 Left		PM 120 Silver	5244.01	5243.01
		Gold	5244.02	5243.02
		Bronze	5244.03	5243.03
		Gold brass	5244.04	5243.04
		White	5244.06	5243.06
		Black	5244.09	5243.09
		Special	5244.99	5243.99
PM 120 Right		PM 120 Silver	5254.01	5253.01
		Gold	5254.02	5253.02
		Bronze	5254.03	5253.03
		Gold brass	5254.04	5253.04
		White	5254.06	5253.06
		Black	5254.09	5253.09
Special	5254.99	5253.99		



Frontal paumelle PF 90

Packaging: 20 units box

		Box (x2)		
PF 90	Left	Silver	5044.01	-
		Gold	5044.02	-
		Bronze	5044.03	-
		Gold brass	5044.04	-
		White	5044.06	-
		Black	5044.09	-
	Special	5044.99	-	
		<hr/>		
PF 90	Right	Silver	5054.01	-
		Gold	5054.02	-
		Bronze	5054.03	-
		Gold brass	5054.04	-
		White	5054.06	-
		Black	5054.09	-
	Special	5054.99	-	

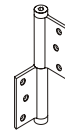

Spring hinge MZ 120

Packaging: 25 units blister

		Box (x20)	Blister (x2)	
MZ 120	al	Silver	6719.01	6717.01
		Gold	6719.02	6717.02
		Bronze	6719.03	6717.03
		White	6719.06	6717.06
		Black	6719.09	6717.09
		<hr/>		
MZ	plastic	Black	I-6710	I-6717

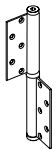

Blade spring hinge with bearing PPM CR

-

		Box (x2)	
PPM CR	240	Iron zinc-plated	I-5234.08
	CR		
		<hr/>	
PPM CR	240	Iron zinc-plated	I-5244.08
	CRP		



Drop spring hinge for welding PG

		Box (x2)	Box (x20)	
PG 120	PG	SST	I-5524.05	I-5529.05
		Iron	I-5524	I-5529
		Iron zinc-plated	I-5524.08	I-5529.08
		<hr/>		
PG 180	PG	SST	I-5324.05	I-5325.05
		Iron	I-5324	I-5325
		Iron zinc-plated	I-5324.08	I-5325.08
		<hr/>		
PG 240	PG	SST	I-5124.05	I-5126.05
		Iron	I-5124	I-5126
		Iron zinc-plated	I-5124.08	I-5126.08

		Box (x15)		
PG CR 180	PG	SST	I-5334.05	I-5335.05
		Iron	I-5334	I-5335
		Iron zinc-plated	I-5334.08	I-5335.08
		<hr/>		
PG CR 240	PG	SST	I-5134.05	I-5136.05
		Iron	I-5134	I-5136
		Iron zinc-plated	I-5134.08	I-5136.08

		Box (x12)		
PG CRP 240	PG	SST	I-5144.05	I-5146.05
		Iron	I-5144	I-5146
		Iron zinc-plated	I-5144.08	I-5146.08

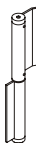

Blade spring hinge for welding PP

		Box (x2)	Box (x12)	
PP 240	PP	Iron	I-5224	I-5226

If you wish to know more about Justor products, have a look at the **general catalogue of Talleres Trepat S.A.** and discover other solutions and our **Blue Line**.

You can also visit our online page www.justor.com

Our products

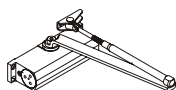

Door closers. Available with arm set. Ready to resist frequent and/or intensive usage, on doors up to 120kg.

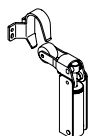

Retaining brakes. They prevent doors from slamming and ensure the total and silent closing of the door.

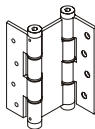

Hinges. Always with a laminated spring set inside, for all types of doors, from screen doors of only 5kg to swing doors of 60kg and iron doors of 250kg.

Blue Line

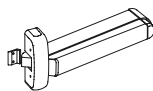

Antipanic. 100% reversible. Certified to be installed on fire doors.



Pin door. Sliding and sliding flush bolts for all types of doors and windows.

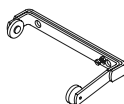

Complements. Complementary products for doors and windows. Addressed to the professional field of aluminium and wood.



www.justor.com

The photographs, images, contents and products presented in this catalogue are of illustrative and orientative character, therefore they will not generate any right or expectation of right, nor are they a binding commercial offer, being they protected by intellectual and industrial property rights in favour of Talleres Trepas S.A.



Talleres Trepats S.A.
Zona industrial "Els Garrofers"
Avda. del Progrés, 40
08340 Vilassar de Mar
(Barcelona) SPAIN

T. +34 937 540 600
F. +34 937 540 601

Spain sales department
trepatventas@justor.com

Export sales department
ttrepatexport@justor.com

www.justor.com